



EcoSEC[®] GPC System

EcoSEC High Temperature GPC System

TSKgel[®] GPC Columns





Tosoh Experience and Expertise

- Introduced the first line of GPC columns in 1971 and a dedicated instrument in 1972
- More than 90% market share in Japan with over 1,500 units in the Asian Market
- Tosoh is the leader in the GPC market in Japan
- 7th generation ambient EcoSEC GPC System
- 3rd generation EcoSEC High Temperature System



Obstacles with Current GPC Systems

- Difficulty achieving a stable RI baseline
- Reproducible results (site-to-site and instrument-to-instrument)
- Long run times and low throughput
- High solvent consumption
- Long warm up and stabilization time
- System dead spots and inconsistent temperature control
- Difficulty separating polymer samples of broad molar mass distribution
- Consistent preparation of calibration standards





The Premise and Promise of Tosoh EcoSEC GPC Systems

Tosoh's EcoSEC GPC Systems are engineered to deliver:

- Superior performance
 - Baseline stability
 - Reproducibility
 - Reliability
- Unparalleled versatility
 - Ease of use
 - All-in-One Design
- Increased throughput
 - Lower operating costs





Performance means Baseline Stability





Performance means Baseline Stability

Both EcoSEC GPC Systems offer a dual pump RI detector:

- Unique use of two, independent pumps
- Most RI detectors contain a single flow cell and a static reference cell which is filled with solvent. Properties of the static solvent in the reference cell change in time.
- Solvent flows through the reference cell of a dual flow cell RI detector. This ensures that the solvents in both cells are identical, thus reducing short and long term noise.
- Baseline stability is essential for the accurate calculation of polymer molar mass averages. *A 2% uncertainty in baseline height will result in a 20% error in M_z .*



Performance means Baseline Stability

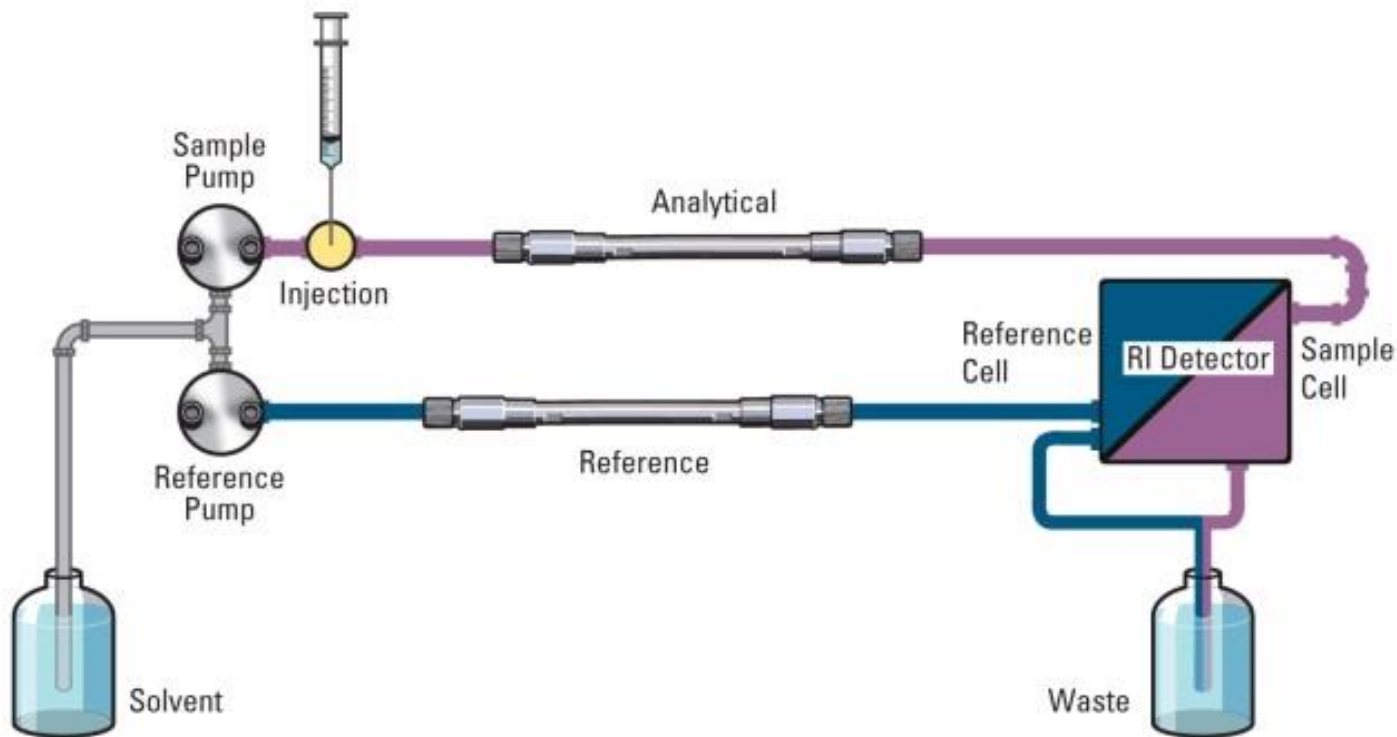

Dual flow RI detector results in low noise and baseline drift, maximum sensitivity, rock steady baselines, and fast system equilibration



Unmatched Baseline Stability

Baseline comparison: DUAL vs Single flow RI detectors in THF

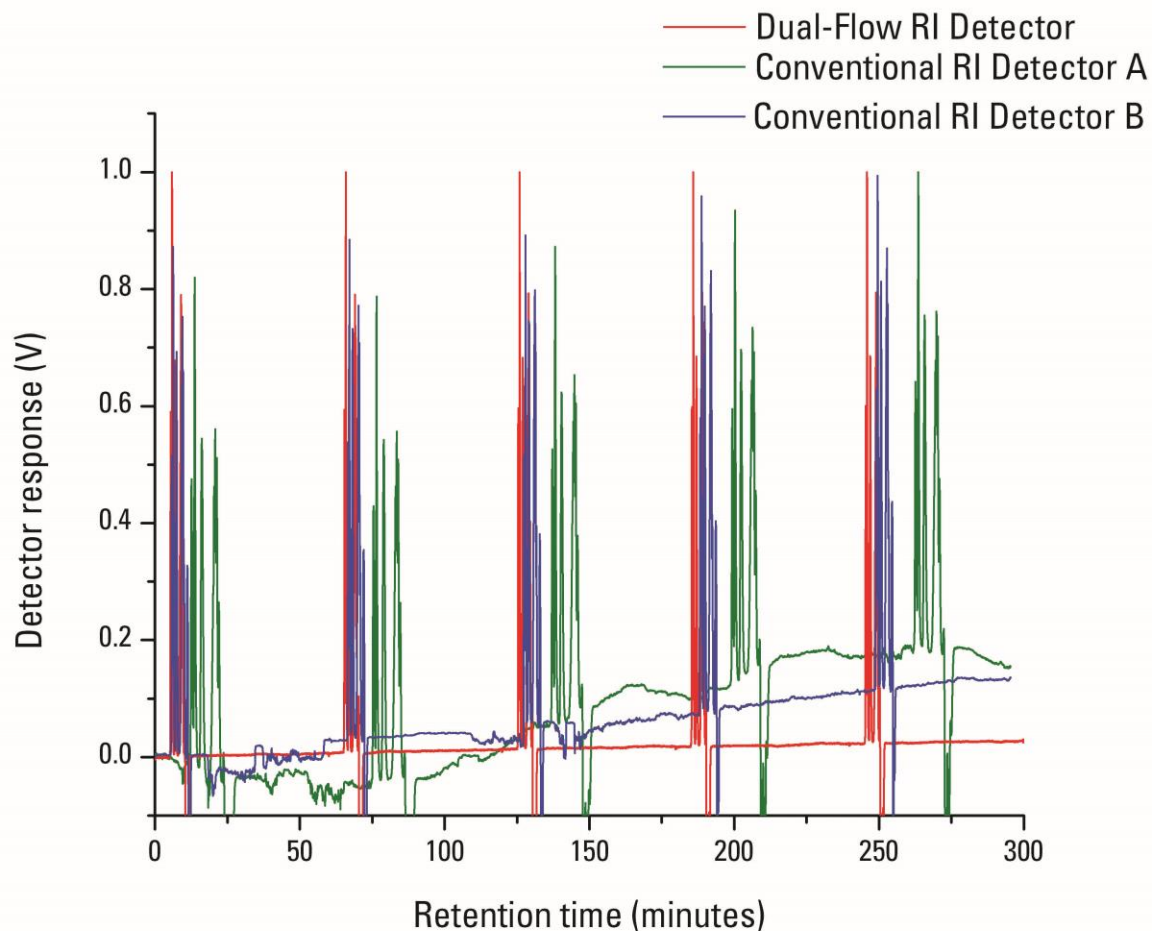



Unmatched Baseline Stability

Baseline stability of EcoSEC GPC System in various solvents

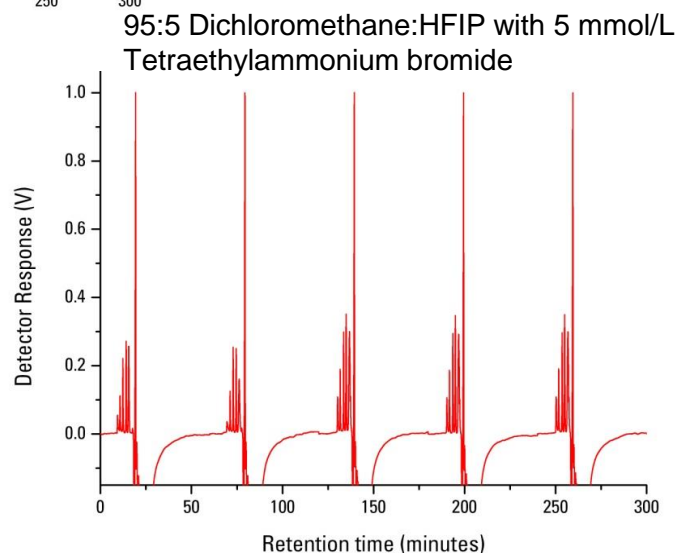
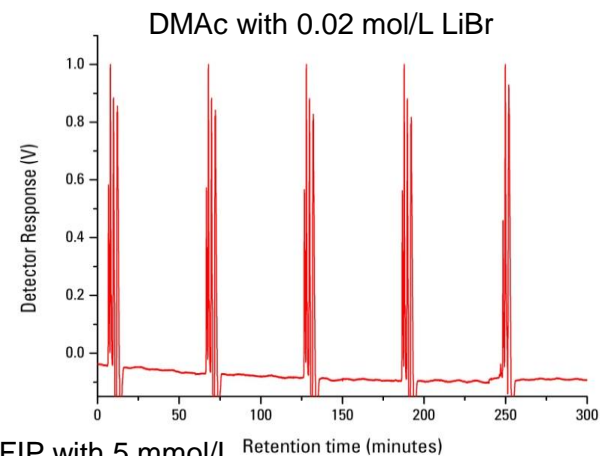
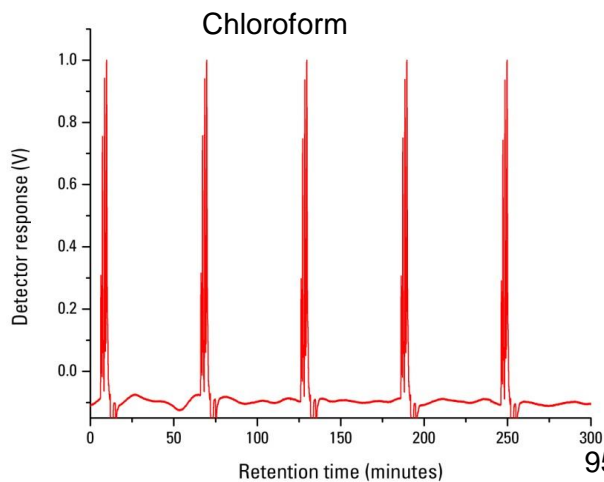



Unmatched Baseline Stability

Baseline stability of common **high temperature** GPC solvents

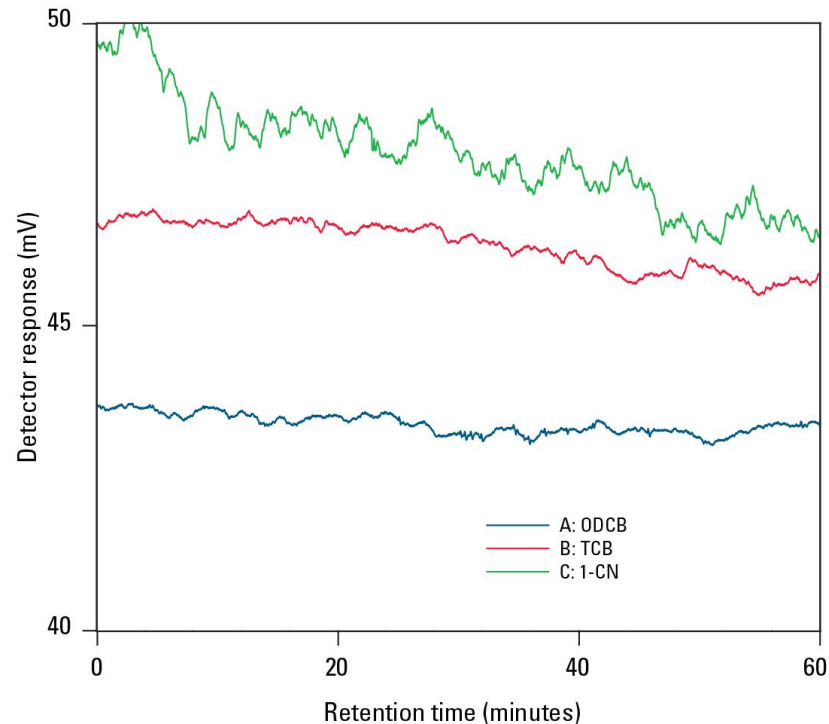

Advanced engineering, along with complete temperature control and a dual flow RI detector, means rock steady baselines in even the most challenging solvents and temperatures.



Performance means Reproducibility





Performance means Reproducibility

Temperature Controlled Pump System

- Both pumps are contained in a temperature controlled environment, ensuring the same flow rate under all circumstances.
- Most HPLC pumps control the flow rate by the volume of solvent in the pump head, which fluctuates with changes in room temperature.
- Both EcoSEC GPC Systems have a dedicated oven for the pumps, which guarantees the same solvent volume in both pump heads at all times despite fluctuations in room temperature.



High Degree of Precision/Exceptional Reproducibility

Room temperature effect on elution time:
Conventional instrument - no pump temperature control

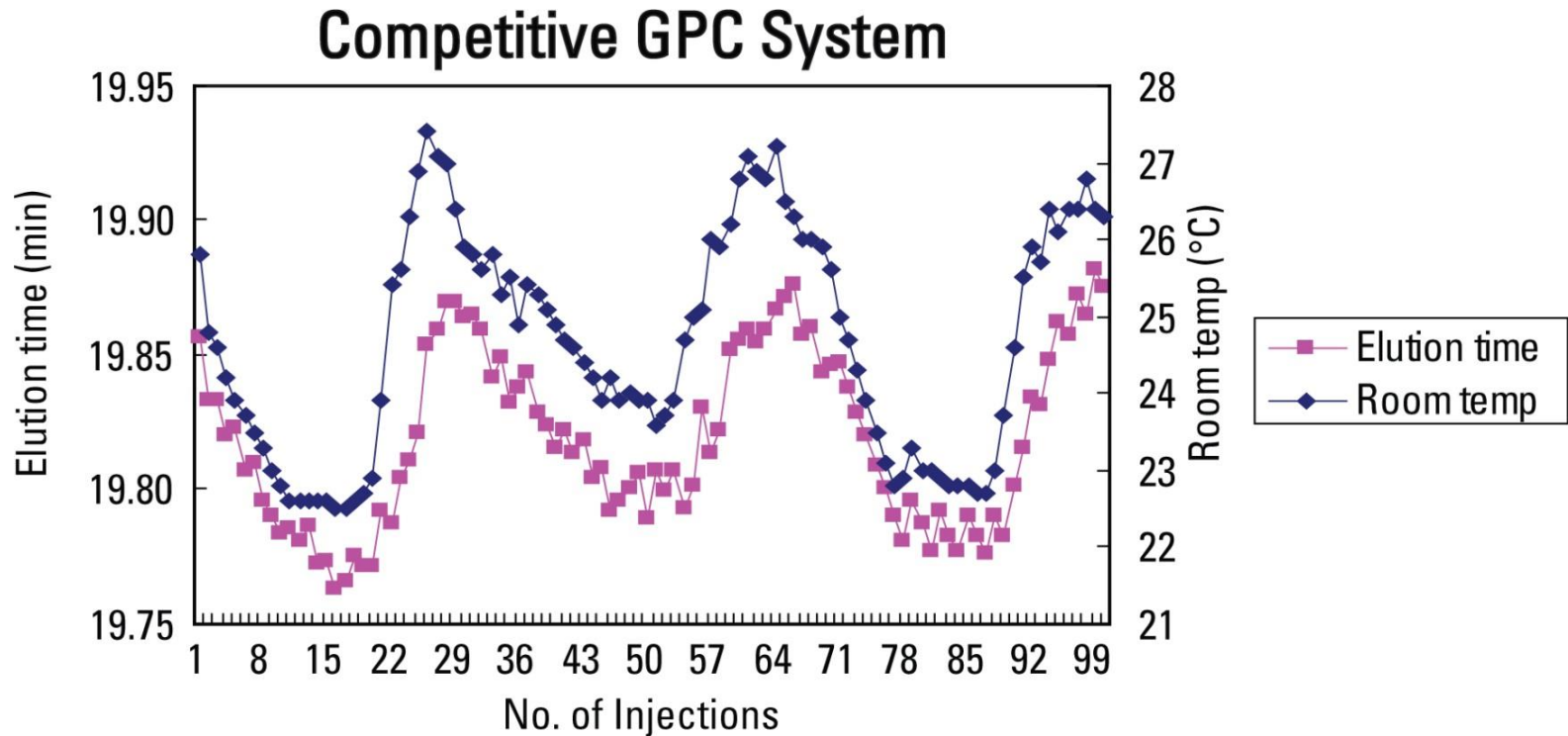



High Degree of Precision/Exceptional Reproducibility

Room temperature effect on elution time:
EcoSEC GPC System - with temperature controlled pumps

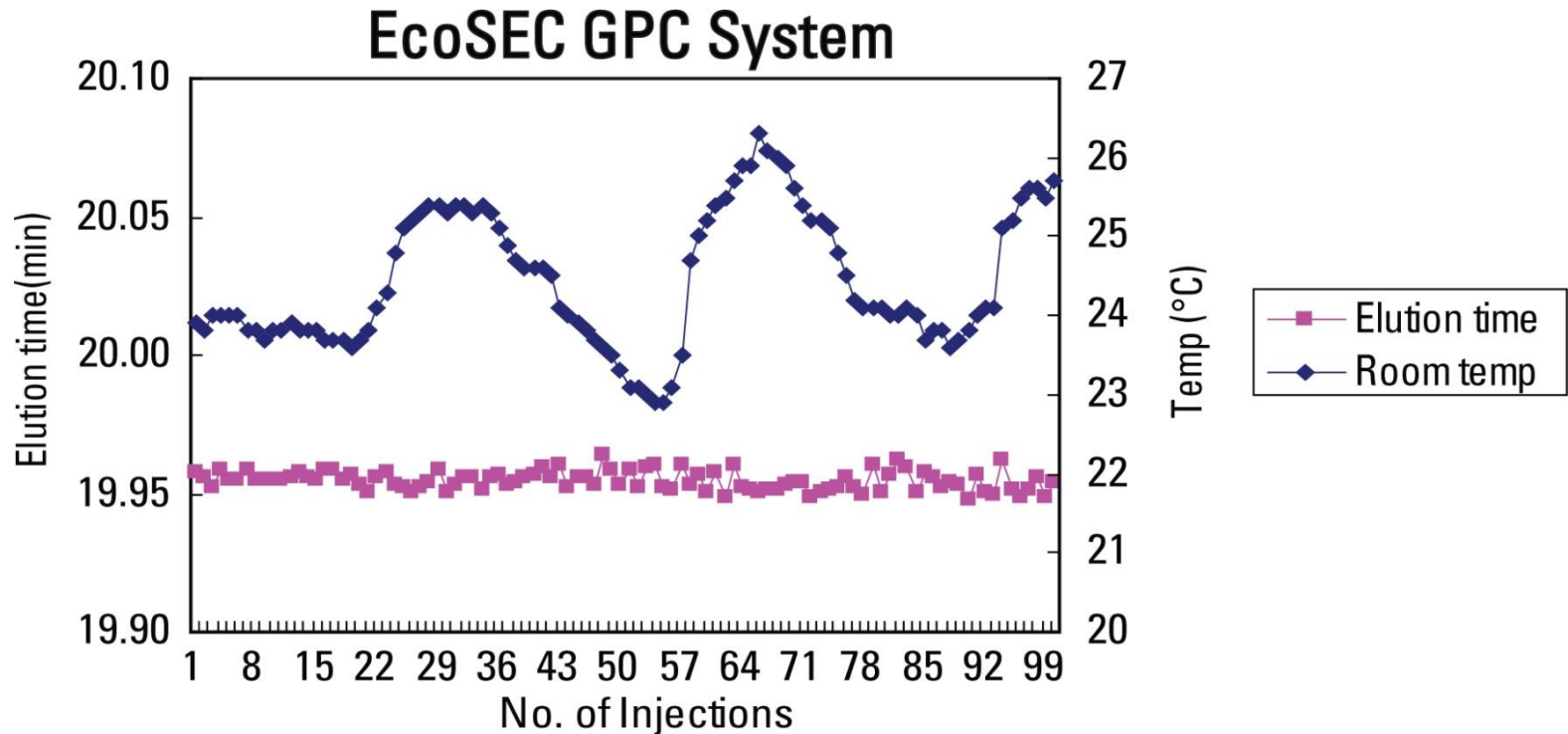



High Degree of Precision/Exceptional Reproducibility

Superior performance- High degree of precision in retention time and molar mass determination due to comprehensive temperature control

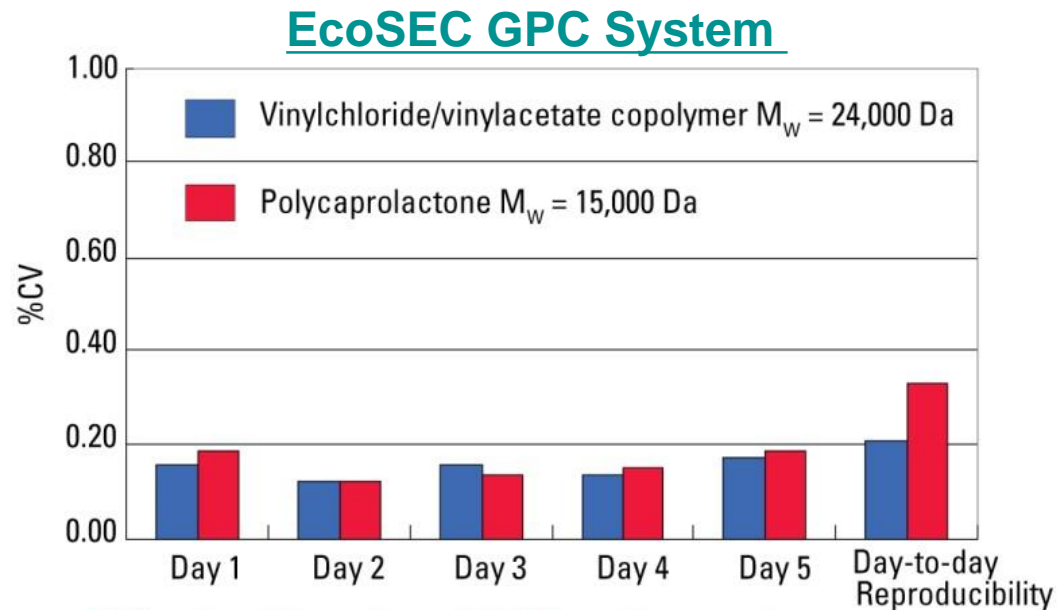

CV value less than 0.2% or less a day.

CV value less than 0.4% on different days.



High Degree of Precision/Exceptional Reproducibility

Superior performance- High degree of precision in retention time and molar mass determination due to comprehensive temperature control

EcoSEC GPC System

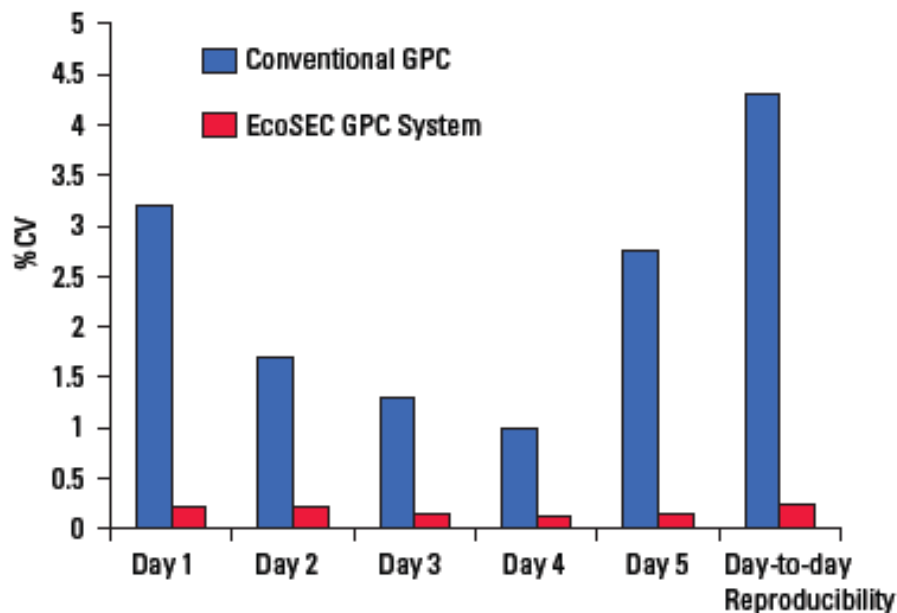



High Degree of Precision/Exceptional Reproducibility

Superior performance- High degree of precision in retention time and molar mass determination due to comprehensive temperature control

EcoSEC High Temperature GPC System

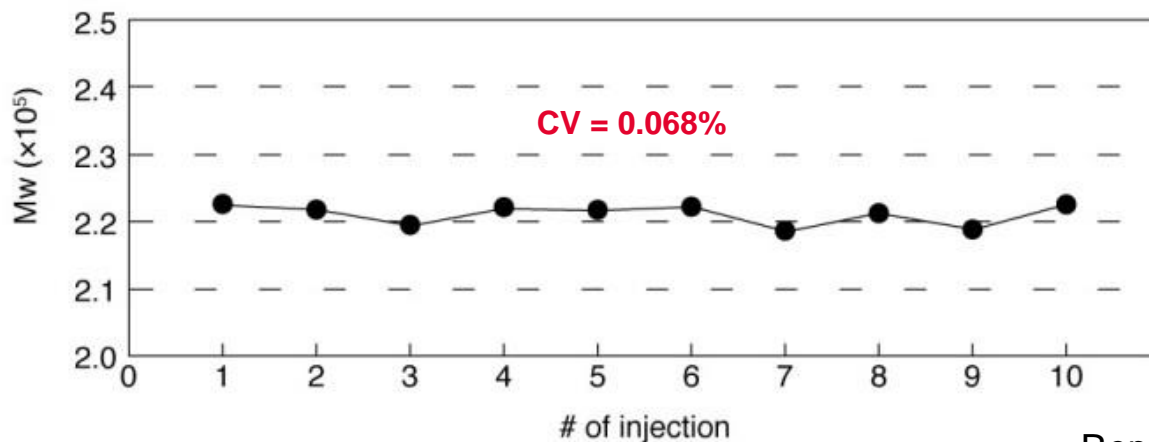

Reproducibility of molar mass for 10 successive injections.



High Degree of Precision/Exceptional Reproducibility

Superior performance- High degree of precision in retention time and molar mass determination due to comprehensive temperature control

Day-to-Day and System-to-System

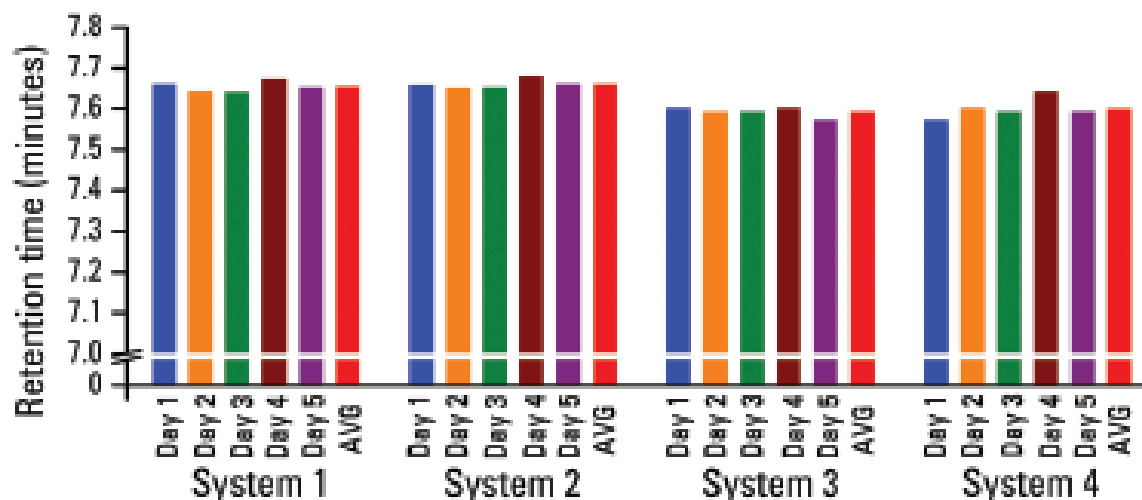

Four EcoSEC GPC Systems, 4 operators,
4 column sets, 4 conditions, one location



High Degree of Precision/Exceptional Reproducibility

Superior performance- High degree of precision in retention time and molar mass determination due to comprehensive temperature control

Site-to-Site

	M_n (g/mol)	M_w (g/mol)	M_z (g/mol)
Site A	1.3×10^4	2.98×10^4	5.37×10^4
Site B	1.37×10^4	2.99×10^4	5.43×10^4
Site C	1.36×10^4	2.98×10^4	5.32×10^4
Site D	1.37×10^4	3.02×10^4	5.41×10^4
Average	1.37×10^4	2.99×10^4	5.38×10^4
Deviation	70	160	420
%CV	0.52	0.55	0.78

Four EcoSEC GPC Systems, 4 operators,
4 column sets, 4 conditions, 4 locations



Performance means Versatility

EcoSEC GPC Systems WorkStation Software

- Fully featured data handling system
- Control EcoSEC GPC System, enter methods, auto start and shut down
- Controls two Systems
- One license for multiple locations
- Consists of 5 programs
 - Acquisition control
 - Analysis
 - Data management
 - Report layout
 - Analytical method validation



Performance means Versatility

Column Switching Valve

- Easy switch between 2 column sets
- Quick baseline stabilization
 - EcoSEC GPC System RI baseline stabilizes after 80 - 90 minutes
 - EcoSEC High Temperature GPC System stabilized within 180 minutes
 - When a new column set is brought online using the column switching valve, the baseline stabilizes after 15 minutes.

This equates to at least a 65 - 75 minute savings in time!



Unparalleled Versatility

Column Switching Valve

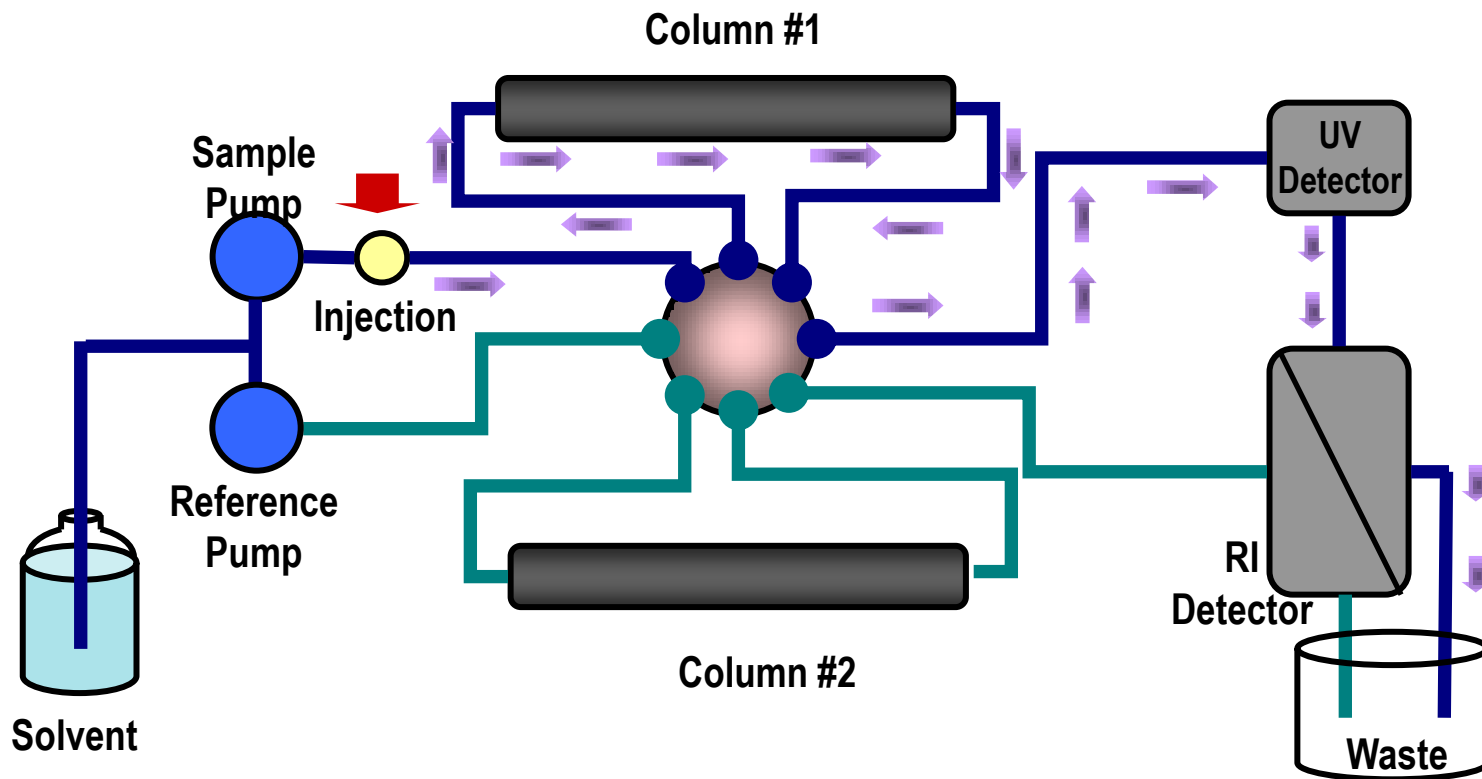



Unparalleled Versatility

EcoSEC GPC System

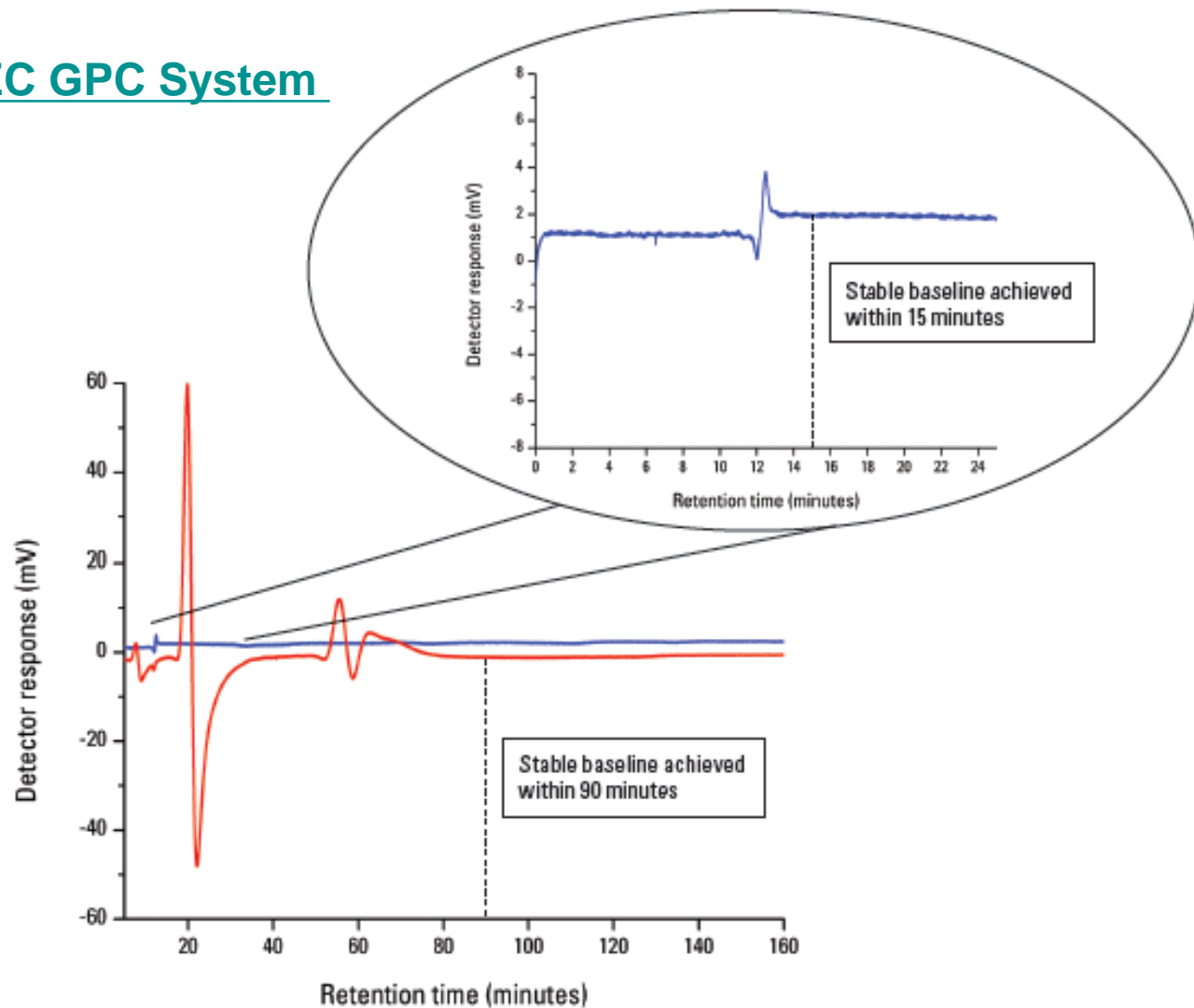



Unparalleled Versatility

EcoSEC High Temperature GPC System

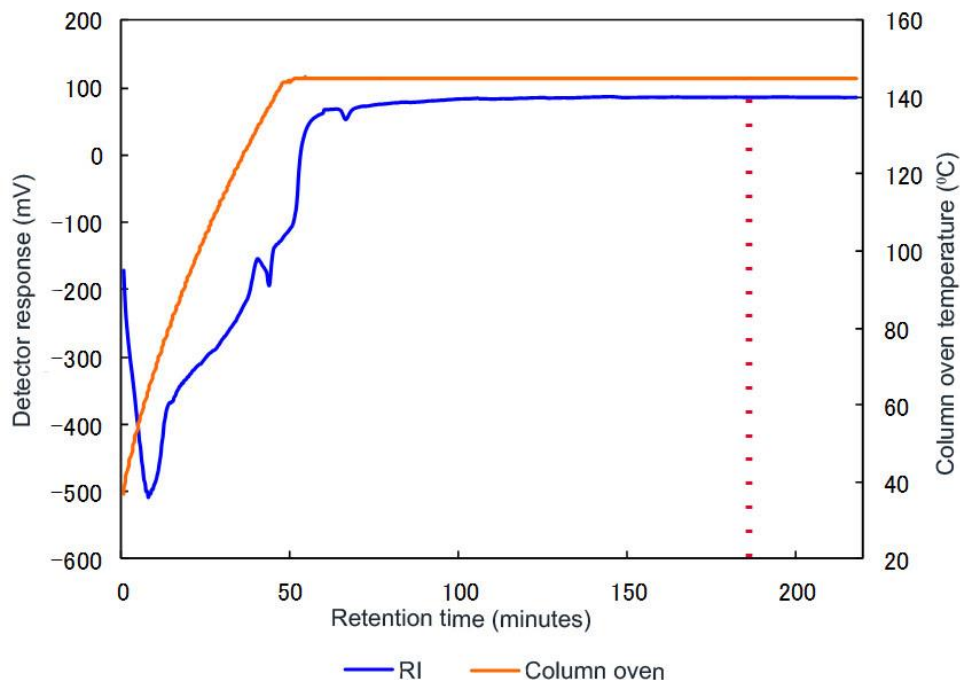

A stable baseline is achieved within 180 minutes.



Unparalleled Versatility

Sample Prep System for EcoSEC High Temperature GPC System

- Dissolves and filters samples
- 24 vial capacity
- Sample shaker, 10 - 100 rpm
- Aluminum heated block
- Temperature controlled 40-220 °C





Performance means Reliability

- TSKgel semi-micro columns are 4.6 mm ID × 15 cm length
- Save time and money: 1/2 the analysis time and 1/6 solvent consumption
- Results with semi-micro SEC columns are only optimized with EcoSEC GPC System - lowest system dead volume available on market today

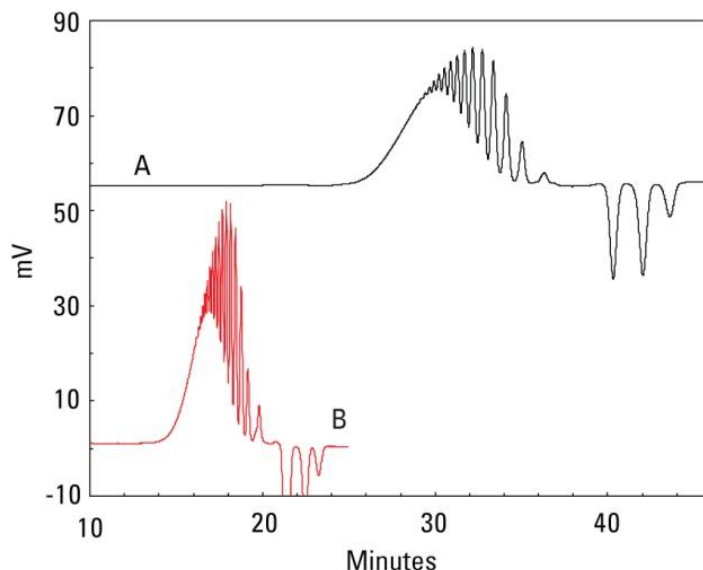

A. Conventional columns, 7.8 mm ID × 30 cm × 4
B. TSKgel SuperMultiporeHZ-N, 4.6 mm ID × 15 cm × 4
Mobile phase: THF
Flow rate: A. 1 mL/min B. 0.35 mL/min
Detection: RI
Temperature: 40 °C
Injection vol.: A. 50 µL B. 10 µL
Sample: poly(teramethylene ether glycol) (PTMEG 650), 10 µg/µL



Performance means Increased Throughput

EcoSEC GPC System

- Analysis time: 1/2
- Lower solvent cost: 1/6 when compared with the traditional GPC column dimensions of 7.8 mm ID × 30 cm
- Plunger volume per stroke: 7.5 μ L
- RI detector cell volume: 2.5 μ L
- Low dead volume in entire system

Solvent	Competitor GPC System	EcoSEC GPC System	Savings
NMP* (\$30/L)	\$3,082	\$1,312	\$1,770
Chloroform (\$17/L)	\$1,830	\$799	\$1,051
DMF* (\$25/L)	\$2,600	\$1,117	\$1,483
HFIP* (\$1,000/L)	\$96,493	\$41,193	\$55,300

*NMP = N-methylpyrrolidone, DMF = dimethylformamide, HFIP = hexafluoroisopropanol



Performance means Reliability

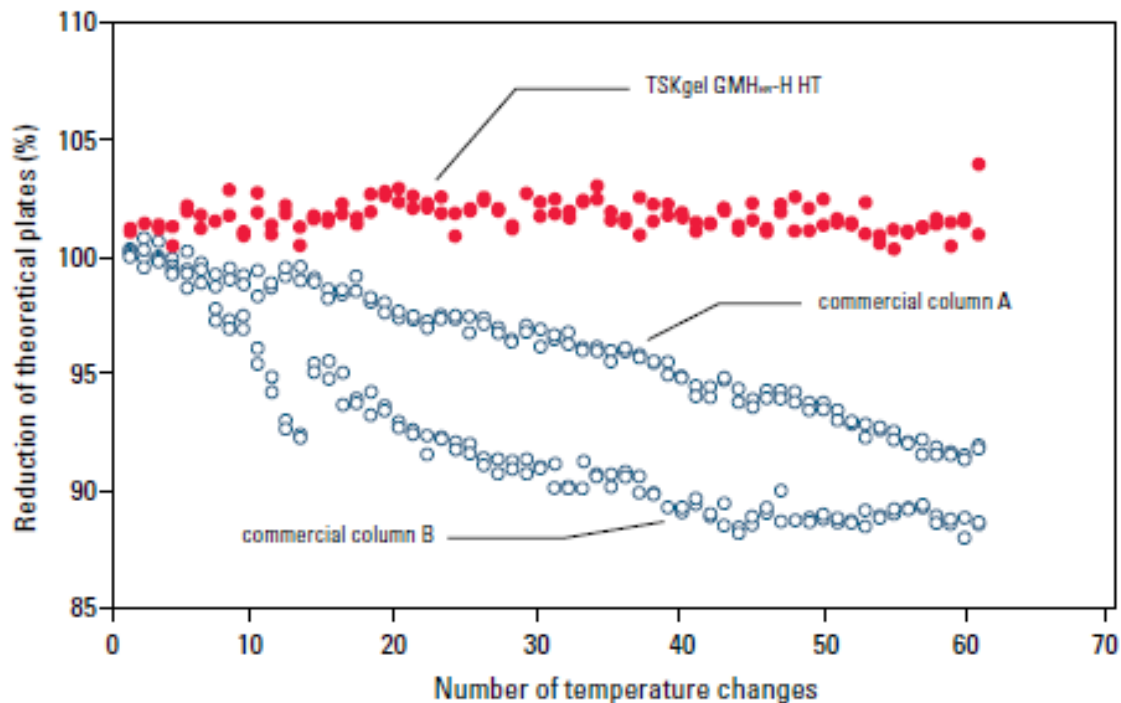

TSKgel GMH_{HR}-H HT column showed stable performance during repetitive rise and fall of column temperatures up to 60 cycles.

Columns were subjected to change of temperature repeatedly; rise in temperature for 2 hours followed by fall in temperature for 2 hours in one cycle.



EcoSEC GPC Systems: A Complete Solution

- All-in-one system with optional detectors and superior TSKgel column technology
- Temperature controlled from injection to waste
- Meets your needs and solves you problems
- Increased throughput/enhanced productivity
- Improved accuracy

